

CATALOG #: \_\_\_\_\_

Type: \_\_\_\_\_

PROJECT: \_\_\_\_\_

## FEATURES

- Spun pole shaft with cast aluminum base provides durability and resists corrosion.
- Designed to accommodate up to two fixtures on a pole top assembly with a maximum 36" O.C. fixture span
- 10' to 18' height options
- An assortment of finishes are available to complement the architectural elements of any outdoor space
- Access door provides easy on-site maintenance

ORDERING EXAMPLE: AV30 - A - 100 - 40 - 156 - T - TM238 - DBR - AB - OPTIONS

## ORDERING INFO

SERIES	MATERIAL	HEIGHT	TOP DIAMETER	WALL THICKNESS	SHAFT STYLE
AV30	A Aluminum	100 10'-0"	40 4"	156 0.156"	T Tapered Round
		120 12'-0"		188 0.188" <sup>[2]</sup>	
		140 14'-0"			
		160 16'-0"			
		180 18'-0"			
		SL___ Special pole length <sup>[1]</sup>			

## SPECIFICATIONS

- SHAFT** – 4" O.D. top tapered round pole spun from seamless 6000 series aluminum alloy.
- POLE TOP** – Plate and tenon provided for top mount luminaire.
- ACCESS DOOR** – Located on structural base. Grounding provision provided.
- FINISH** – Polyester powder coat bonded to pretreated metal, meets AAMA 2604 specifications for outdoor durability.
- ANCHOR BOLTS** – Conform to ASTM F1554 Grade 55, galvanized a minimum of 12" on the threaded end.
- MOUNTING** – Structural base cast from 356 alloy aluminum. The pole is inserted and welded into the structural base casting. The completed assembly is heat-treated to a T6 temper. A mounting template is provided with each pole and anchor bolt order.

FIXTURE MOUNTING <sup>[3]</sup>	FINISH <sup>[4]</sup>	ANCHOR BOLTS	OPTIONS
<b>POLE TOP MOUNT</b>	<b>BLK</b> Black <sup>[6]</sup>	<b>AB</b> Anchor bolts <sup>[10]</sup>	<b>FS</b> Festoon box only <sup>[12]</sup>
<b>TM238</b> 2-3/8" x 4" Round tenon	<b>DBR</b> Medium bronze	<b>LAB</b> Less anchor bolts	
<b>TM278</b> 2-7/8" x 4" Round tenon	<b>DBZ</b> Dark bronze	<b>PAB</b> Pre-shipped Anchor Bolts <sup>[11]</sup>	
<b>TM3</b> 3" x 4" Round tenon	<b>GRAY</b> Standard gray		
<b>TC___</b> Custom Round Tenon <sup>[5]</sup>	<b>GRN</b> Green <sup>[7]</sup>		
	<b>SLV</b> Satin aluminum <sup>[8]</sup>		
	<b>WHT</b> White <sup>[9]</sup>		
	<b>RAL#___</b> Specify custom color		

## NOTES

- Please specify, consult factory.
- 140, 160, and 180 Heights only.
- Designed for pole top tenon mount. See page 2 for MOUNTING DETAILS.
- See page 2 for FINISH OPTIONS.
- Must specify tenon diameter and height, consult factory.
- RAL #9004.
- RAL #6005.

- RAL #9006.
- RAL #9003.
- Four L-bolts provided with two hex nuts and two flat washers each, shipped with pole.
- Four L-bolts provided with two hex nuts and two flat washers each.
- Casting only. Outlet, cover and hardware by others.

# AV30 Aluminum Tapered Round Pole & Base

## FIXTURE DETAILS

### BASE DETAIL

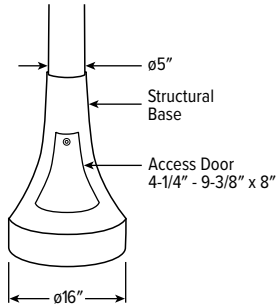

## MOUNTING DETAILS

### POLE TOP MOUNT TYPICAL TENON

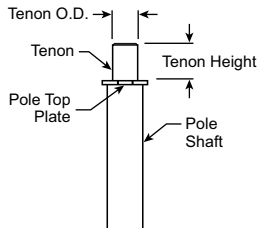

### ANCHORAGE DATA

#### BOLT PROJECTION

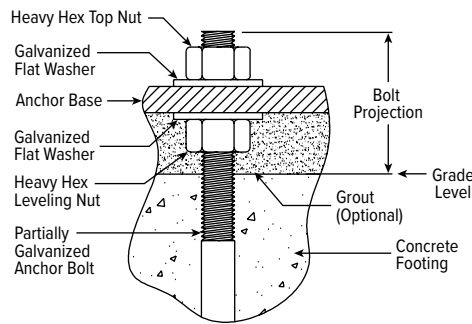

#### ANCHOR BASE

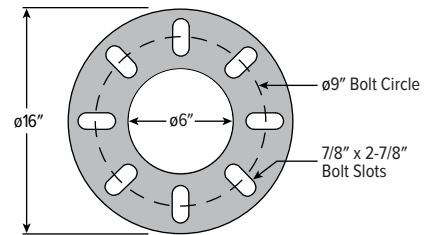

ANCHOR BOLTS <sup>1</sup>			ANCHOR BASE		
BOLT SIZE	PROJECTION	±	BOLT CIRCLE		THK.
			DIA.	±	
3/4" x 17" x 3"	3-1/2"	N/A	9"	N/A	16"

<sup>1</sup> Provided with four anchor bolts. Base has eight slots for additional orientation.

## OPTION DETAILS

### ALUMINUM FESTOON BOX

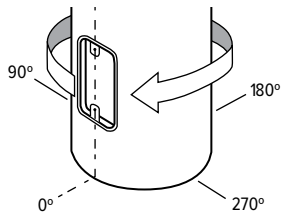

NOTE: The festoon box is located above the access door at 0°.

## FINISH OPTIONS

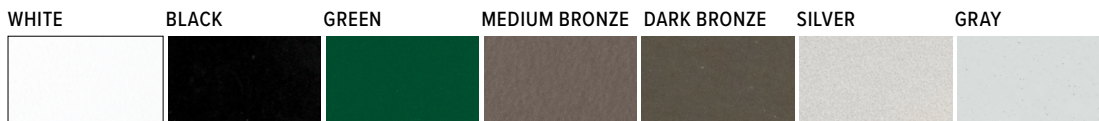

For custom color, please specify RAL code or a manufacturer code with description. All custom colors other than RAL require two sample swatches, minimum 1" square.

# AV30 Aluminum Tapered Round Pole & Base

## LOAD AND DIMENSIONAL DATA

POLE HT. (FT)	CATALOG NUMBER	POLE DIMENSIONS				80 MPH <sup>1,2</sup>		90 MPH <sup>1,2</sup>		100 MPH <sup>1,2</sup>	
		BASE O.D. (IN)	TOP O.D. (IN)	WALL THK. (IN)	STRUC. WT <sup>3</sup> (LBS)	MAX LUMINAIRE EPA (SQ FT)	MAX LUMINAIRE WEIGHT (LBS)	MAX LUMINAIRE EPA (SQ FT)	MAX LUMINAIRE WEIGHT (LBS)	MAX LUMINAIRE EPA (SQ FT)	MAX LUMINAIRE WEIGHT (LBS)
10	AV30-A-100-40-156-T	5	4	0.156	57	17.2	120	13.4	120	10.8	120
12	AV30-A-120-40-156-T	5	4	0.156	62	14.3	120	11.0	120	8.8	120
14	AV30-A-140-40-156-T	5	4	0.156	67	11.5	120	8.8	120	6.9	120
	AV30-A-140-40-188-T	5	4	0.188	73	14.1	120	10.8	120	8.6	120
16	AV30-A-160-40-156-T	5	4	0.156	72	9.3	120	7.0	120	5.5	120
	AV30-A-160-40-188-T	5	4	0.188	79	11.5	120	8.7	120	6.9	120
18	AV30-A-180-40-156-T	5	4	0.156	77	7.5	120	5.5	120	4.2	120
	AV30-A-180-40-188-T	5	4	0.188	85	9.4	120	7.0	120	5.4	120

<sup>1</sup> Effective Projected Area (EPA) calculations allow for 1.3 Wind Gust Factor. Maximum EPA and weight values are based on top mounted luminaires or arm assembly having a centroid 3'-0" above and 3'-0" eccentric to the pole top at Nominal Mounting Height. Variations from sizes above are available upon inquiry. Satisfactory performance of poles is dependent upon the pole being properly attached to a supporting foundation of adequate design.

<sup>2</sup> See WIND MAP below.

<sup>3</sup> Structure Weight is a nominal value which includes the pole shaft and structural base.

▪ Pole installations in various parts of the country perform satisfactorily; however, in select locations destructive vibration can occur. H.E. Williams, Inc. is not responsible for vibration induced fatigue damage.

▪ H.E. Williams, Inc. warrants this product to be free from defects in materials and workmanship. Any defective part returned within one year from the date of delivery of the goods will be repaired or replaced without charge, F.O.B. factory.

▪ This warranty specifically excludes fatigue or similar phenomena resulting from induced vibration, harmonic oscillation or resonance associated with movement of air currents around the product.

▪ The above warranties are given in lieu of all other warranties express or implied, including without limitation, the warranty of merchantability and the warranty of suitability for a particular purpose. It is expressly stated that H.E. Williams, Inc. assumes no liability for consequential or liquidated damages arising out of a breach of the sale, including any warranties arising therefrom, and buyer's remedy shall be limited to repair or replacement of defective parts as described above.

▪ Any action for the breach under a sale including any warranties arising therefrom must be commenced within one year after the cause of action accrues.

## WIND MAP

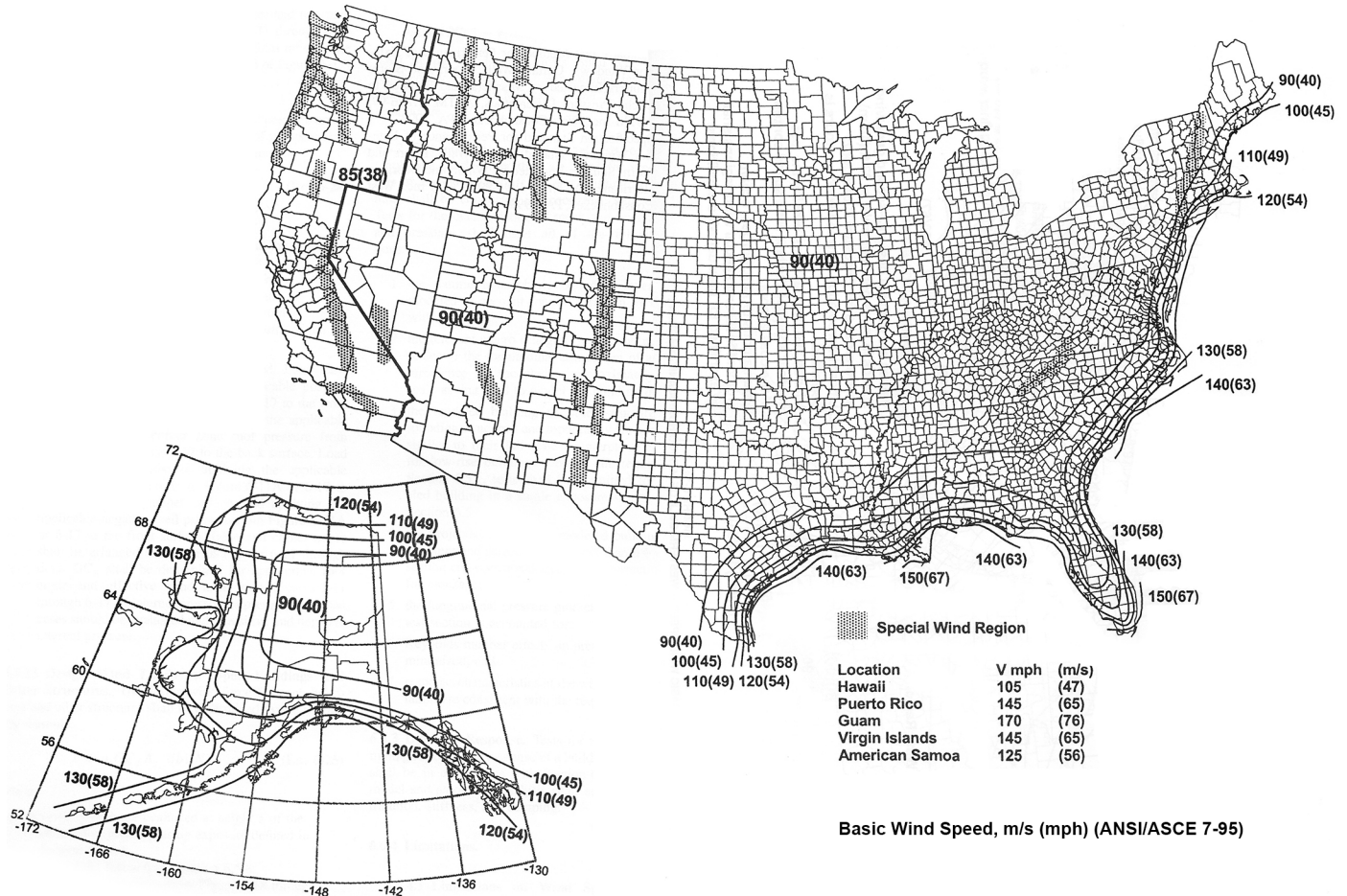

The Effective Projected Area (EPA) standards shown in the Load and Dimensional Data Tables on the specification sheets are designed to withstand dead loads and theoretical dynamic loads developed by variable wind speeds, as charted, with an appropriate wind gust factor under the following conditions:

- Values are nominal design 3-second gust wind speeds in miles per hour (m/s) at 33 ft (10 m) above ground for Exposure C category.

- Linear Interpolation between wind contours is permitted.
- Islands and coastal areas outside the last contour shall use the last wind speed contour of the coastal area.
- Mountainous terrain, gorges, ocean promontories, and special wind regions shall be examined for unusual wind conditions.
- This map is intended as a general guide. Check your local area for unique wind conditions.

From Standard Specifications for Structural Support for Highway Signs, Luminaires, and Traffic Signals, Copyright 2009, by the American Association of State Highway and Transportation Officials, Washington D.C. Used by permission. Documents may be purchased from the AASHTO bookstore at 1-800-231-3475 or online at bookstore.transportation.org