

**INSTRUCTIONS APPLY TO THE FOLLOWING SERIES:**

**NOTE: SM75, SM76 END PLATES ARE SPOTWELDED TO CHANNEL**  
 75, 76, 77, 78, 80, 81, 82, 83, 85

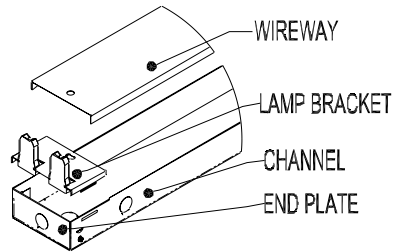

**INSTRUCTIONS APPLY TO THE FOLLOWING SERIES:**

79, 79A, 79AW, 79W

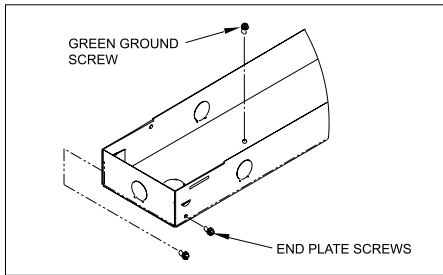
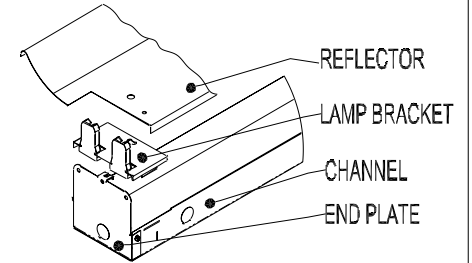

(Step 1) SERIES: 75, 76, 77, 78, 80, 81, 82, 83, 85 INSTRUCTIONS SNAP-IN END PLATE ONTO CHANNEL AND INSTALL SCREWS ON END PLATE WITH SNAP-IN OPTION ONLY.

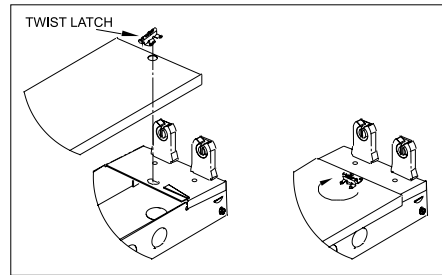

(Step 4) SERIES: 75, 76, 77, 78, 80, 81 INSTRUCTIONS INSTALL TWIST LATCH INTO WIREWAY AND SECURE ONTO LAMP BRACKET.

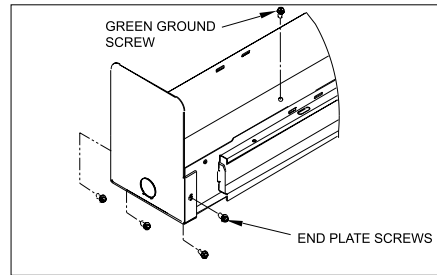

(Step 1) SERIES: 79W, 79AW INSTRUCTIONS POSITION END PLATE ONTO CHANNEL AND INSTALL SCREWS.

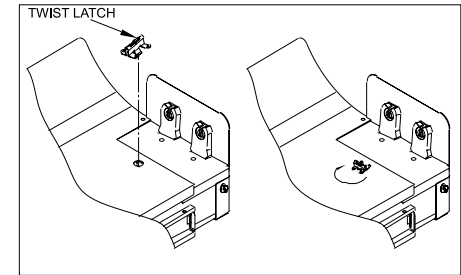

(Step 4) SERIES: 79W, 79AW INSTRUCTIONS INSTALL TWIST LATCH INTO REFLECTOR AND SECURE ONTO LAMP BRACKET.

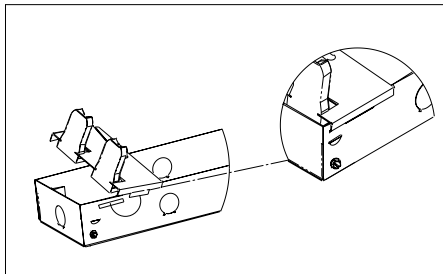

(Step 2) ALIGN ANGLED FLANGE IN LAMP BRACKET WITH SLOT IN CHANNEL. SLIGHTLY SQUEEZE CHANNEL SIDES; HINGE LAMP BRACKET OVER CHANNEL.

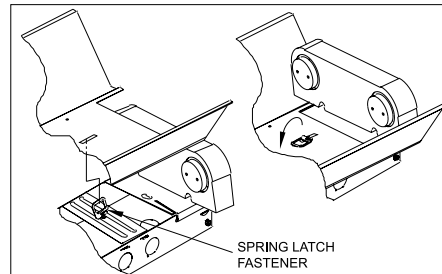

(Step 5) SERIES: 82 AND 83 INSTRUCTIONS ALIGN SPRING LATCH FASTENERS WITH SLOT IN REFLECTOR. PULL SPRING LATCH UPWARD AND ROTATE 1/4 TURN. FOLD SPRING LATCH DOWN.

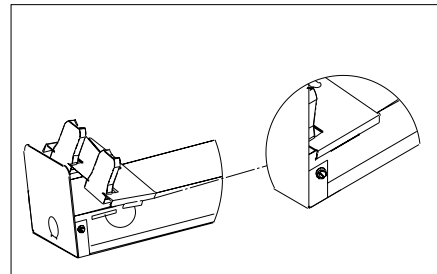

(Step 2) ALIGN ANGLED FLANGE IN LAMP BRACKET WITH SLOT IN CHANNEL. SLIGHTLY SQUEEZE CHANNEL SIDES; HINGE LAMP BRACKET OVER CHANNEL.

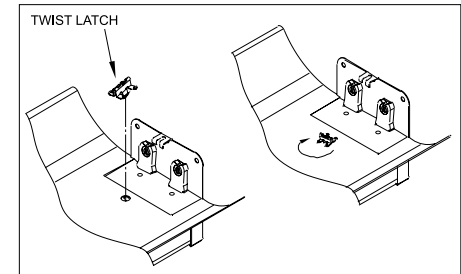

(Step 5) SERIES: 79A INSTRUCTIONS INSTALL TWIST LATCH INTO REFLECTOR AND SECURE ONTO LAMP BRACKET.

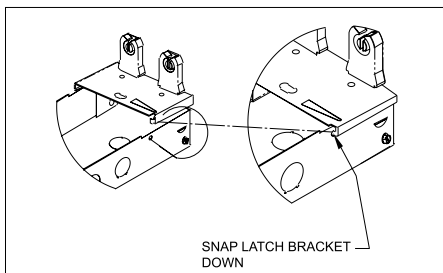

(Step 3) ON OTHER SIDE OF CHANNEL, ALIGN PROTRUDING TAB WITH HOLE IN CHANNEL.

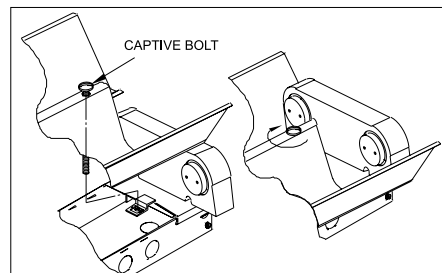

(Step 6) SERIES: 85 INSTRUCTIONS ALIGN REFLECTOR AND CAPTIVE BOLT ONTO LAMP BRACKET. SECURELY FASTEN TO LAMP BRACKET.

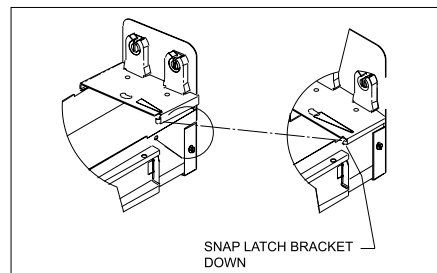

(Step 3) ON OTHER SIDE OF CHANNEL, ALIGN PROTRUDING TAB WITH HOLE IN CHANNEL.

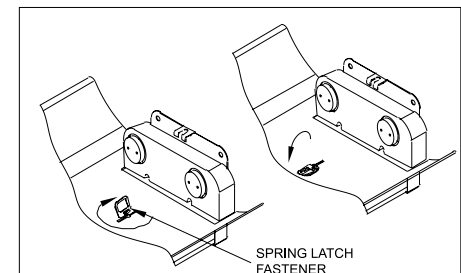

(Step 6) SERIES: 79 INSTRUCTIONS ALIGN SPRING LATCH FASTENER WITH SLOT IN REFLECTOR. PULL SPRING LATCH UPWARD AND ROTATE 1/4 TURN. FOLD SPRING LATCH DOWN.

## Instructions for Continuous Row Mounting of 74 Series Strips

1. Insert tabs into slots of adjoining fixtures and bend tabs up 90° to lock fixtures together.

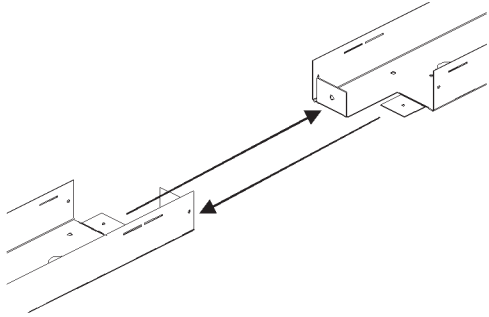

2. Secure tabs via screws into the holes on the tabs connecting the fixtures.

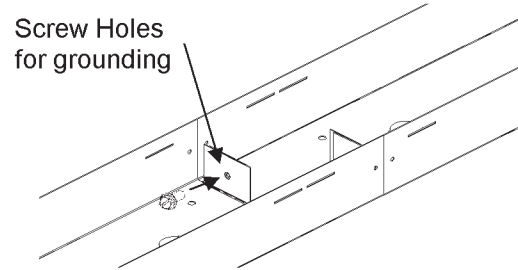

3. Install end plate on each fixture at row ends. Insert screws into holes on side of end plates to secure to the fixture.

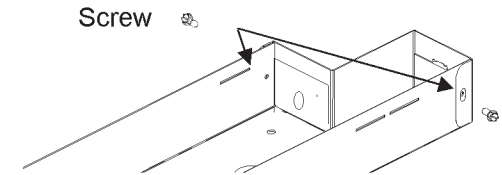

**Note:** If power supply enters fixture through end plate remove continuous row tab from channel by breaking it off before installing end plate.

4. Install lamp brackets. Insert tabs into the appropriate slots on each side of the housing.

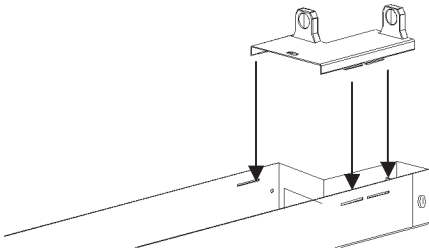

5. Place wireway cover onto fixture. Secure via twist latch.

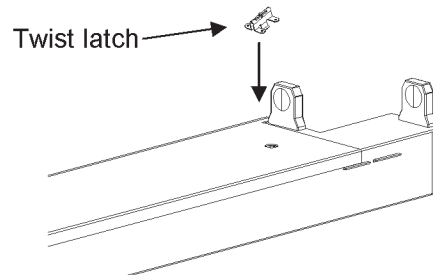

6. Install lamps once all other steps have been completed.

